



GUARANTEEING YOU THE GREENEST REFRIGERATION AVAILABLE



EPROG600X Cabinet with LTR-5CSRE-A Controller



Service Manual



ISO 14001



ISO 9001



Contents









Manual Information & Health & Safety Notes	1
Environmental Management Policy	2
Disposal Requirements	2
EPROG600X Description	3
Controller Operation	3 to 4
Configuration of Parameters	4
Technical Data	4
Cabinet Controller Default	5
Wiring Diagram	6
Troubleshooting & Notes	7

Service Manual Information

The products and all information in this manual are subject to change without prior notice. We assume by the information given that the person(s) working on these refrigeration units are fully trained and skilled in all aspects of their workings. Also that they will use the appropriate safety equipment and take or meet precautions where required.

The service manual does not cover information on every variation of this unit; neither does it cover the installation or every possible operating or maintenance instruction for the units.

Health & Safety Warnings and Information

	Make sure the power supply is turned off before making any electrical repairs.
	To minimise shock and fire hazards, please do not plug or unplug the unit with wet hands.
	During maintenance and cleaning, please unplug the unit where required.
	Care must be taken when handling or working on the unit as sharp edges may cause personal injury, we recommend the wearing of suitable PPE.
	Ensure the correct moving and lifting procedures are used when relocating a unit.
	Do NOT use abrasive cleaning products, only those that are recommended. Never scour any parts of the refrigerator. Scouring pads or chemicals may cause damage by scratching or dulling polished surface finishes.
	Failure to keep the condenser clean may cause premature failure of the motor/compressor which will NOT be covered under warranty policy.
	Do NOT touch the cold surfaces in the freezer compartment. Particularly when hands are damp or wet, skin may adhere to these extremely cold surfaces and cause frostbite.
	Please ensure the appropriate use of safety aids or Personnel Protective Equipment (PPE) are used for you own safety.

Environmental Management Policy for Service Manuals and Duets.

Product Support and Installation Contractors

Foster Refrigerator recognises that its activities, products and services can have an adverse impact upon the environment.

The organisation is committed to implementing systems and controls to manage, reduce and eliminate its adverse environmental impacts wherever possible, and has formulated an Environmental Policy outlining our core aims. A copy of the Environmental Policy is available to all contractors and suppliers upon request.

The organisation is committed to working with suppliers and contractors where their activities have the potential to impact upon the environment. To achieve the aims stated in the Environmental Policy we require that all suppliers and contractors operate in compliance with the law and are committed to best practice in environmental management.

Product Support and Installation contractors are required to:

1. Ensure that wherever possible waste is removed from the client's site, where arrangements are in place all waste should be returned to Foster Refrigerator's premises. In certain circumstances waste may be disposed of on the client's site; if permission is given, if the client has arrangements in place for the type of waste.
2. If arranging for the disposal of your waste, handle, store and dispose of it in such a way as to prevent its escape into the environment, harm to human health, and to ensure the compliance with the environmental law. Guidance is available from the Environment Agency on how to comply with the waste management 'duty of care'.
3. The following waste must be stored of separately from other wastes, as they are hazardous to the environment: refrigerants, polyurethane foam, and oils.
4. When arranging for disposal of waste, ensure a waste transfer note or consignment note is completed as appropriate. Ensure that all waste is correctly described on the waste note and include the appropriate six-digit code from the European Waste Catalogue. Your waste contractor or Foster can provide further information if necessary.
5. Ensure that all waste is removed by a registered waste carrier, a carrier in possession of a waste management licence, or a carrier holding an appropriate exemption. Ensure the person receiving the waste at its ultimate destination is in receipt of a waste management licence or valid exemption.
6. Handle and store refrigerants in such a way as to prevent their emission to atmosphere, and ensure they are disposed of safely and in accordance with environmental law.
7. Make arrangements to ensure all staff who handle refrigerants do so at a level of competence consistent with the City Guilds 2078 Handling Refrigerants qualification or equivalent qualification.
8. Ensure all liquid substances are securely stored to prevent leaks and spill, and are **not** disposed of to storm drains, foul drain, or surface water to soil.

Disposal Requirements

If not disposed of properly all refrigerators have components that can be harmful to the environment. All old refrigerators must be disposed of by appropriately registered and licensed waste contractors, and in accordance with national laws and regulations.

EPROG600X Description

The cabinets are manufactured as a one piece foamed shell.

Temperature is controlled by a microprocessor control with digital temperature display.

The heated air is circulated the heater element, via the fan into the storage area.

The cabinets conform to current legislation and exceed the Montreal protocol using zero ODP refrigerants and insulation

Temperature is controlled by a LAE microprocessor control with digital temperature display.

All models are fitted with lockable swivel castors to the front and swivel castors to the rear.

Controller Operation

Probe Air SN4K150P1 (00-556187)



LTR-5CSRE-A Controller (00-556186)



Set point Button.



Increase Button.



Decrease Button.



Exit/Stand-by Button.

Display

During normal operation, the display shows either the temperature measured or one of the following indications:

oFF Controller in stand-by

or Probe T1 Out of range or failure





TUN / 5.4 Controller in autotuning

E1 In tuning: timeout1 error

E2 In tuning: timeout2 error

E3 In tuning: overage error

Set point (display and modification of desired temperature value)

- Press button  for at least half second, to display the set point value.
- By keeping button pressed, use button  or  to set the desired value (adjustment is within the minimum **SPL** and the maximum **SPH** limit).
- When button  is released, the new value is stored.









Stand-By

Button , when pressed for 3 seconds, allows the controller to be put on a standby or output control to be resumed (with **SB=YES** only). In standard settings mode, this facility is disabled.

Hysteresis & Auto tuning Modes

The controller is capable of either Hysteresis or Autotuning modes. For the FHC500X, the controller uses Hysteresis and therefore Autotuning is disabled and should not be reactivated.

Recalibration

- Have a precision reference thermometer or a calibrator to hand.
- Ensure that **OS1=0** and **SIM=0**.
- Switch the controller off then on again.
- During the auto-test phase, press buttons  ·  and keep them both pressed till the controller shows **0AD**.
- With buttons  or  select **0AD** or **SAD**: **0AD** allows a calibration of 0, inserting a constant correction over the whole scale of measurement. **SAD** allows a calibration of the top part of the measurement scale with a proportional correction between the calibration point and 0.
- Press  to display the value and then use  +  or  make the read value coincide with the value measured by the reference instrument.
- Exit from calibration by pressing button 

Technical Data - LTR-5CSRE-A

Power supply

LTR-5...E 230Vac±10%, 50/60Hz, 2W
 LTR-5...U 115Vac±10%, 50/60Hz, 2W

Relay outputs (LTR-5..R..)

LTR-5.SR.. OUT1 16(4)A

Inputs

LTR-5C...: NTC 10KΩ@25°C, part No. LAE SN4...

Measuring Range

LTR-5C...: -40...125°C

Measuring accuracy

LTR-5C...: <±0.3°C -40...100°C; ±1°C out of that range

Operating conditions

-10 ... +50°C; 15...80% R.H.

CE (Reference Norms)







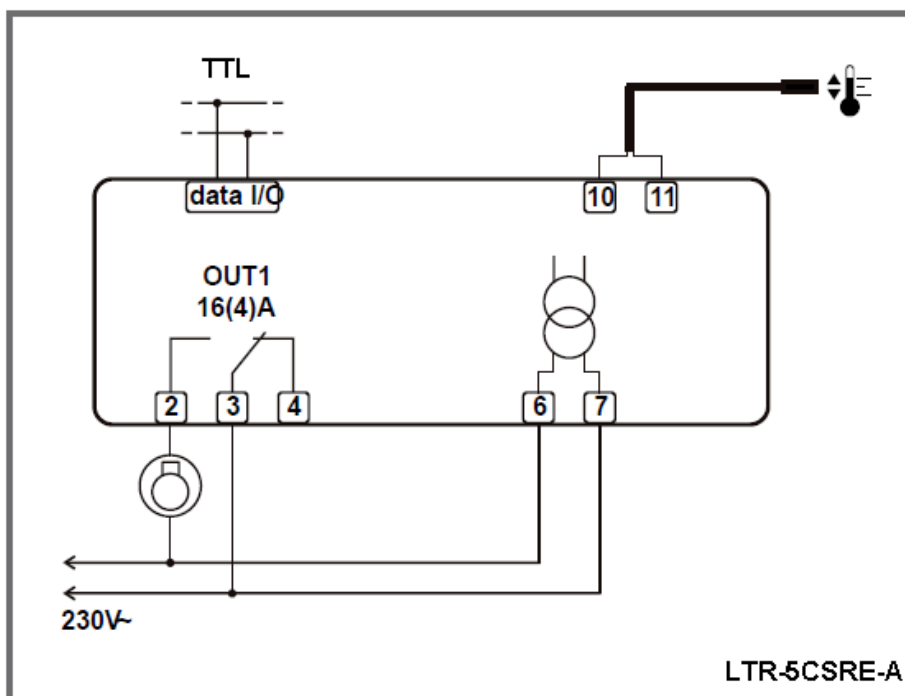



EN60730-1; EN60730-2-9;
 EN55022 (Class B);
 EN50082-1

Front protection

IP55 & VIA



Configuration of Parameters

- Setup menu is accessed by pressing buttons  +  or 5 seconds.
- With button  or  elect the parameter to be modified.
- Press button  to display the value.
- By keeping button  pressed, use button  or  to set the desired value.
- When button  is released, the newly programmed value is stored and the following parameter is displayed.
- To exit from the setup, press button  or wait for 30 seconds.

Default Parameter Values for Controller and EPROG600X

LTR 5CSRE-A Parameter List							EPROG600X
Reg	Parameter	Description	Min.	Max	Dim.	Default	
233	SCL	Readout scale	1°C / 2°C / °F		flag	1°C	2°C
200	SPL	Minimum set point [I]	-50	SPH	°C	-19.9	83
202	SPH	Maximum set point [I]	SPL	150	°C	99.9	90
204	1SP	Set point [I]	SPL	SPH	°C	40	87
212	1Y	Control Type	HY	PID	flag	hy	HY
212	1HY	Change-over hysteresis [I]	-19.9	19.9	°K	-5	-3
214	1PB	Proportional band	-19.9	19.9	°C	-5	6
215	1IT	Integral action time	0	999	sec.	350	1
216	1DT	Derivative action time	0	999	sec.	50	4
217	1AR	Reset of integral action	0	100	%	90	15
206	1CT	Cycle time	0	255	sec.	10	20
219	1PF	Status with faulty sensor	ON / OFF		flag	OFF	OFF
220	BAU	Operation of auxiliary button	NON / SBY		flag	NON	NON
234	SIM	Display slowdown	0	100	flag	0	3
236	OS1	Sensor correction	-12.5	12.5	°K	0	0
235	ADR	Unit address	1	255	flag	1	1

Wiring Diagram for EPROG600X with LTR 5CSRE-A Controller

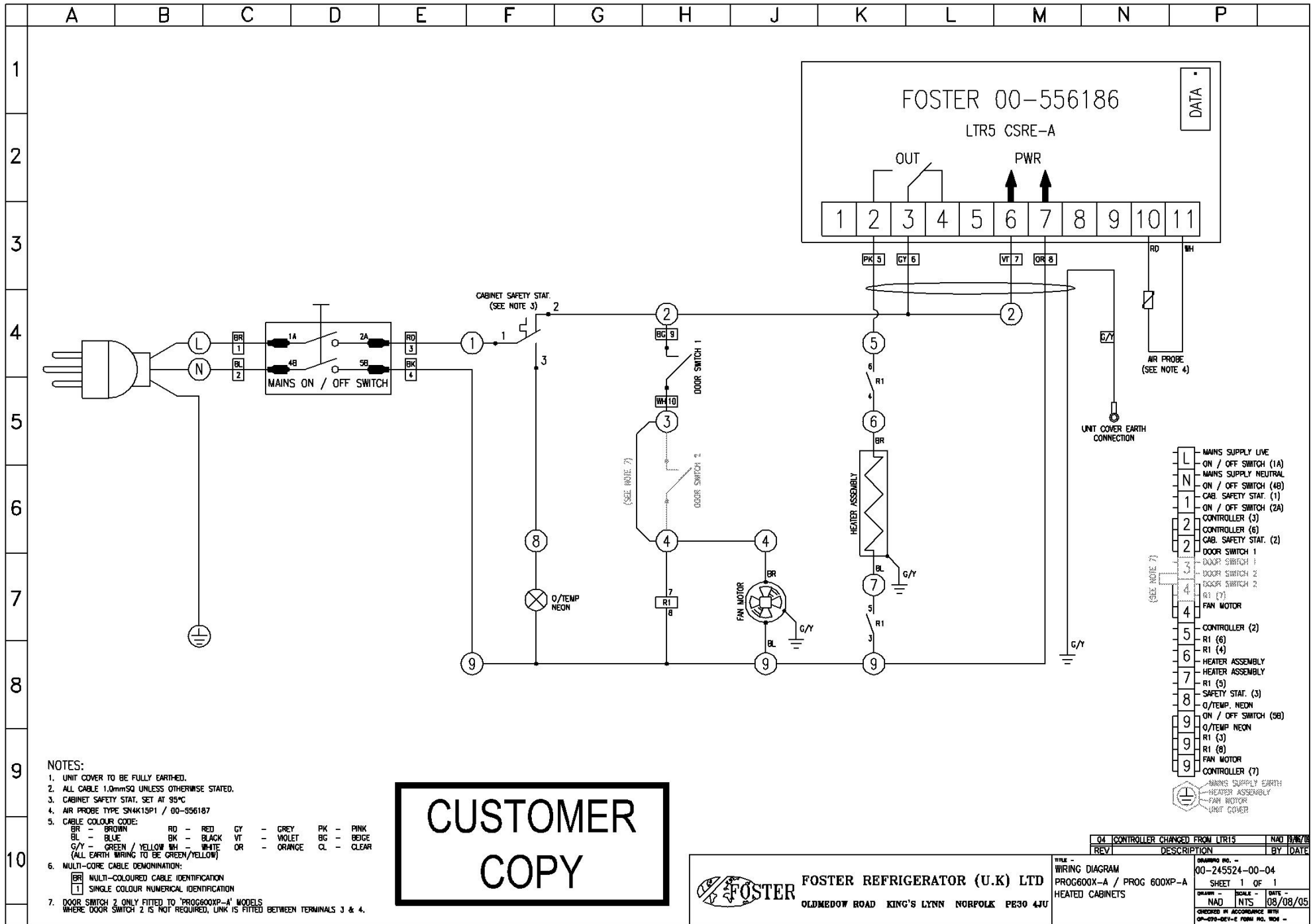

CUSTOMER COPY



FOSTER REFRIGERATOR (U.K) LTD
OLDMEDOW ROAD KING'S LYNN NORFOLK PE30 4JU

04	CONTROLLER CHANGED FROM LTR15	NAD 19/06/05
REV	DESCRIPTION	BY / DATE
DRAWING NO. - 00-245524-00-04		
WIRING DIAGRAM		
PROG600X-A / PROG 600XP-A		
HEATED CABINETS		
SHEET 1	OF 1	
DRAWN - NAD	SCALE -	DATE - 08/08/05
CHECKED IN ACCORDANCE WITH		
OP-070-001-E FORM NO. 1006 -		

Troubleshooting

Problem	Possible Cause	Solution
No display on the controller and red neon illuminated	Safety thermostat tripped	Reset and investigate cause.
Unit not heating and the fan is not running	No output from controller	a. Check controller relay output b. Fan may be faulty c. Check the heater.
Unit not heating and fan is running	No output from the controller	Check controller relay output
	Faulty heater	Check the heater and replace as necessary
	Faulty relay	Check relay and replace as necessary
Main on, neon not illuminated with unit switched on. 	Fuse blown in plug	Check and replace if necessary
	No electrical supply at the socket	Check socket
	Faulty Mains Lead	Check & replace as necessary
Safety thermostat trips regularly	Fan running too slow	Check and replace as necessary
	Incorrectly set thermostat	Adjust as necessary

Notes



Foster European Operations

France

Foster Refrigerator France SA

Tel: (33) 01 34 30 22 22. Fax: (33) 01 30 37 68 74.

Email: commercial@fosterfrance.com

Germany

Foster Refrigerator GmbH,

Tel: (49) 781 990 7840. Fax (49) 781 990 7844.

Email: info@foster-gmbh.de

Foster Refrigerator

Oldmedow Road

Kings Lynn

Norfolk

PE30 4JU

Tel: 0843 216 8833

Fax: 0843 216 4707

Website: www.fosterrefrigerator.co.uk

Email: support@foster-uk.com

a Division of 'ITW (UK) Ltd'

EPROG CAB/ LTR5/SM 07/10